



GTX 335/345

All-In-One ADS-B Transponder

Pilot's Guide



© 2016-2018 Garmin Ltd. or its subsidiaries. All rights reserved.

This manual reflects the operation of GTX 3X5 transponders.

Except as expressly provided herein, no part of this manual may be reproduced, copied, transmitted, disseminated, downloaded or stored in any storage medium, for any purpose without the express written permission of Garmin. Garmin hereby grants permission to download a single copy of this manual and of any revision to this manual onto a hard drive or other electronic storage medium to be viewed for personal use, provided that such electronic or printed copy of this manual or revision must contain the complete text of this copyright notice and provided further that any unauthorized commercial distribution of this manual or any revision hereto is strictly prohibited.

This document complies with Garmin Banned and Restricted Substances document, P/N 001-00211-00.

Bluetooth® word mark and logos are registered trademarks owned by Bluetooth SIG, Inc. and any use of such marks by Garmin is under license.

For information about the [Aviation Limited Warranty](#) refer to Garmin's website.

Visit flyGarmin.com for aviation product support.

**WARNING**

Do not use data link weather information for maneuvering in, near, or around areas of hazardous weather. Information contained within data link weather products may not accurately depict current weather conditions.

**WARNING**

Do not use the indicated data link weather product age to determine the age of the weather information shown by the data link weather product. Due to time delays inherent in gathering and processing weather data for data link transmission, the weather information shown by the data link weather product may be significantly older than the indicated weather product age.

**WARNING**

This product, its packaging, and its components contain chemicals known to the State of California to cause cancer, birth defects, or reproductive harm. This notice is being provided in accordance with California's Proposition 65. If you have any questions or would like additional information, please refer to our website at www.garmin.com/prop65/.

**WARNING**

To reduce the risk of unsafe operation, carefully review and understand all aspects of the GTX 3X5 Pilot's Guide. Thoroughly practice basic operation prior to actual use.

**WARNING**

The display surface is coated with a special anti-reflective coating that is very sensitive to skin oils, waxes, and abrasive cleaners. It is very important to clean the lens using an eyeglass lens cleaner that is specified as safe for anti-reflective coatings with a clean, lint-free cloth.

**WARNING**

Traffic information is provided as an aid in visually acquiring traffic. Pilots must maneuver the aircraft based only upon ATC guidance or positive visual acquisition of traffic.

**CAUTION**

Unauthorized repairs or modifications could result in permanent damage to the equipment, and void your warranty and your authority to operate this device under FCC and FAA regulations.

**NOTE**

The coverage expected for all operations (transponder replies to ATC, ADS-B and FIS-B reception) from the Garmin GTX 3X5 is limited to line of sight. Low altitude or aircraft antenna shielding by the aircraft itself may result in reduced range. Range can be improved by climbing to a higher altitude.

**NOTE**

This product does not contain any user-serviceable parts. Repairs should only be made by an authorized Garmin service center.

**NOTE**

It is the responsibility of the GTX 3X5 owner, residing outside of the U.S., to obtain proper licensing before using the transponder.

**NOTE**

For debugging purposes, Garmin uses data logging to capture real-time flight information. This information is retrievable only by an authorized installer.

Product Registration and Support

Help us better support you by completing your online registration. To register, have your product's serial number on hand. Visit www.Garmin.com and click the Product Registration link on the home page. Be sure to record your serial number in the space provided below.

Serial Number: _____

This guide is available electronically at: www.garmin.com/manuals

If you have any questions, visit flyGarmin.com

Record of Revisions			
Part Number	Revision	Date	Description
190-01499-00	A	02/12/16	Initial release.
	B	08/12/16	Added rotorcraft information.
	C	09/09/16	Minor edits.
	D	07/11/18	Added FIS-B information.
	E	08/02/18	Minor edits.
	F	10/08/18	Added debugging note to page ii and NOTAM note to section 5.

Abbreviations and Acronyms

ADS-B	Automatic Dependant Surveillance-Broadcast
ADS-R	Automatic Dependent Surveillance-Rebroadcast
AHRS	Attitude and Heading Reference System
ATC	Air Traffic Control
ATCRBS	Air Traffic Control Radar Beacon System
BLE	Bluetooth Low Energy
FIS-B	Flight Information Services-Broadcast
PED	Portable Electronic Device
PIREP	Pilot Report
SSR	Secondary Surveillance RADAR
TAS	Traffic Advisory System
TCAS	Traffic Collision Avoidance System
TFRs	Temporary Flight Restrictions
TIS	Traffic Information Service
TIS-B	Traffic Information Service-Broadcast

Sources and References

Automatic Dependent Surveillance–Broadcast (ADS-B) is an important part of the FAA's NextGEN effort. ADS-B is a precise GPS-based surveillance system that provides ATC access to traffic data well beyond the capabilities of RADAR alone. It enables the display of precise traffic data in cockpits equipped to receive ADS-B.

For more information about ADS-B, visit the Garmin ADS-B Academy website. www.garmin.com/us/intheair/ads-b/

For more information about ADS-B and other NextGEN programs, visit the FAA NextGEN website. www.faa.gov/nextgen/

1	GTX 3X5 Series Transponders	1-1
1.1	GTX 335 Transponder	1-1
1.2	GTX 345 Transponder	1-1
2	GTX 3X5 Controls	2-1
2.1	Panel Mount Transponder Controls	2-1
2.2	Mode Selection Keys	2-1
2.3	Squawk Code Keys	2-3
2.4	Function Keys	2-4
2.5	Remote Transponder Control	2-4
3	Display Functions and Settings	3-1
3.1	Transponder (XPDR)	3-1
3.2	Timers (TMR)	3-2
3.3	Altitude (ALT)	3-3
3.4	System (SYS)	3-4
3.4.1	Bluetooth Pairing Instructions	3-5
3.4.2	Bluetooth Paired Device Information	3-5
4	ADS-B IN Traffic (GTX 345 Only)	4-1
4.1	Traffic Alerting	4-2
4.2	Helicopter Traffic Alerting	4-2
4.2.1	On Scene Mode	4-2
4.2.2	No Source of Heading Data	4-3
4.3	TCAD/TAS/TCAS I GTX 345 Integration	4-3
5	FIS-B Weather and Flight Information	5-1
6	Connex Bluetooth	6-1
7	Troubleshooting	7-1
7.1	Transponder Failures	7-1
7.2	Transponder System Messages	7-2

List of Figures

Figure 2-1	Squawk Code Entry Field	2-3
Figure 3-1	Flight ID Edit Display Page	3-1
Figure 3-2	Flight ID Editable Display Page	3-1
Figure 3-3	Bluetooth Page	3-5
Figure 3-4	Bluetooth Pair Request Page	3-5
Figure 3-5	Paired Device List Page	3-5
Figure 3-6	Auto-reconnect Page	3-5
Figure 3-7	Unpair Device? Page	3-6
Figure 3-8	(Selected) Bluetooth Device Name Page	3-6
Figure 7-1	ADS-B 1090 Failed Screen	7-1
Figure 7-2	ADS-B 1090 and Transponder Failed Screen	7-1

List of Tables

Table 2-1	Mode Section Key Functions	2-2
Table 2-2	Squawk Code Key Functions	2-3
Table 2-3	Squawk Codes	2-3
Table 2-4	Function Keys	2-4
Table 5-1	FIS-B Weather Products	5-2
Table 6-1	GTX 345 Connex Features	6-1
Table 7-1	Troubleshooting	7-2

This page intentionally left blank.

1 GTX 3X5 SERIES TRANSPONDERS

The GTX 3X5 Series Transponders are panel mount and remote transponders. Both models are TSO-C112e (Level 2ens, Class 1) compliant mode S transponders with TSO-C166b compliant ADS-B Out 1090 MHz Extended Squitter functionality.

1.1 GTX 335 Transponder

GTX 335 Features:

- ADS-B Out
- TIS traffic display output and aural alerting
- Altitude deviation alerting
- Timers: count up, count down, flight, trip
- Static (Outside) air temperature display
- Density and pressure altitude display
- Internal GPS (Optional)

For more information on TIS traffic refer to the display operator's manual and the FAA Aeronautical Information Manual (AIM), 4-1-17.

1.2 GTX 345 Transponder

The GTX 345 includes ADS-B In functionality, when connected to a suitable display.

GTX 345 Features:

- ADS-B Out
- Dual-band ADS-B In traffic display output and aural alerting
- Integration with TCAD/TAS/TCAS I traffic systems
- FIS-B weather and flight information display output
- Bluetooth interface provides traffic, FIS-B, and other air data to a Portable Electronic Device (PED)
- Altitude deviation alerting
- Timers: count up, count down, flight, trip
- Static (Outside) air temperature display
- Density and pressure altitude display
- Internal GPS (Optional)

This page intentionally left blank.

2 GTX 3X5 CONTROLS

2.1 Panel Mount Transponder Controls

The GTX 3X5 series transponders have an auto-dimming display and keypad layout. The keys access the transponder's controls and features.



- ON** Powers on, disables altitude reporting.
- ALT** Powers on, enables altitude reporting.
- VFR** Changes to the preprogrammed squawk code for VFR.
- OFF** Powers off.
- SBY** Powers on or changes into standby mode.
- IDNT** Activates the Ident function.

2.2 Mode Selection Keys



NOTE



The transponder system no longer supports a pilot selectable GND mode. The transponder should always be in ALT mode prior to moving on the airport surface. It must be in ALT mode when operating in certain controlled airspace, in accordance with 14 CFR 91.215. For guidance on transponder operation, refer to the FAA Aeronautical Information Manual (AIM), 4-1-20(a)(3).

When on the ground or in the air always operate the transponder in ALT mode, unless otherwise requested by ATC. It is acceptable to go directly from OFF to ALT mode. It is not necessary to place in SBY mode for a "warm up" period. The transponder automatically determines whether the aircraft is in the air or on the ground and sends that information to other aircraft and ATC.

Automatic ALT Mode Switching

If the unit is configured for Automated Airborne Determination and senses a transition from on ground to in air, the unit automatically switches from SBY to ALT mode.

Table 2-1 Mode Section Key Functions

ON	<ul style="list-style-type: none"> ◦ The ON key selects the on mode. ◦ The transponder replies to interrogations. Replies do not include pressure altitude. ◦ The Reply () symbol on the display indicates the transponder is responding.
ALT	<ul style="list-style-type: none"> ◦ The ALT key selects the alt mode. ◦ Always use Alt mode while in the air and on the ground, unless otherwise requested by ATC. ◦ All aircraft air/ground state transmissions are handled via the GTX 3X5 transponder and require no pilot action. ◦ The transponder replies to identification and altitude interrogations. ◦ The Reply () symbol indicates the transponder is responding. ◦ The GTX 3X5 transmissions include pressure altitude.
VFR	<ul style="list-style-type: none"> ◦ The VFR key sets the transponder code to the preprogrammed VFR code. This is factory set to 1200, but may be changed during installation configuration. ◦ To restore the previous identification code, press the VFR key a second time. ◦ To toggle between these two codes, continue to press the VFR key.
IDENT	<ul style="list-style-type: none"> ◦ The IDENT key activates the IDENT function for 18 seconds. This sets the transponder apart from others on the air traffic controller's screen. ◦ During this time the word "IDENT" will appear in the upper left corner of the display.
SBY	<ul style="list-style-type: none"> ◦ The SBY key selects the standby mode. ◦ The transponder will not reply to any interrogations or transmit ADS-B Out. ◦ If BT functions are enabled, BT functionality remains operational. ◦ The GTX 345 will continue to receive ADS-B In information, but will not be a TIS-B participant.

2.3 Squawk Code Keys



There are eight squawk code entry keys (0 – 7). They provide access to all ATCRBS codes. Pressing one of the squawk code entry keys begins the code selection sequence. Digits that are not yet entered appear as underscored blanks. When the fourth digit is entered the new code is activated.

Table 2-2 Squawk Code Key Functions

Press the CLR key to move the cursor back to the previous digit.
Press and hold the CLR key to move the cursor back to the first digit.
Pressing the CLR key when the cursor is on the first digit removes the cursor and cancels the code entry, retaining the last code entered.
Pressing the CRSR key when entering the code removes the cursor and cancels the code entry. The last code entered is retained.



Figure 2-1 Squawk Code Entry Field

Table 2-3 Squawk Codes

Code	Description
7600	Enter code if there is a loss of communication. "LOST COMM" displays under the squawk field.
7700	Enter code if there is a general emergency. "EMERGENCY" displays under the squawk field.

2.4 Function Keys

Table 2-4 Function Keys

FUNC	The FUNC key cycles through four menu groups shown on the right-hand side of the display. Menu groups include: <ul style="list-style-type: none"> ◦ Transponder (XPDR) ◦ Timers (TMR) ◦ Altitude (ALT) ◦ System (SYS)
ENT	The ENT key acknowledges the selection of menu items and pilot data entry fields.
CRSR	The CRSR key activates the cursor to select items in menus and on pages.
CLR	The CLR key clears selected entry and exits the menus.
8▲	The key enters the number eight in the Flight ID or Count Down timer. It navigates up and between the functions and settings within a menu group.
9▼	The key enters the number nine in the Flight ID or Count Down timer. It navigates down and between the functions and settings within a menu group.

2.5 Remote Transponder Control

The GTX 3X5 transponder functions are controllable from connected, Garmin certified displays (e.g., GTN) or G1000 integrated flight deck. When the GTX 3X5 is installed in a location other than the cockpit instrument panel, remote control from a display is the only GTX 3X5 flight crew interface available.

Remote transponder control includes:

- Squawk code
- Transponder mode
- IDENT
- ADS-B transmit control*
- Flight ID*
- TIS traffic enable/disable (GTX 335 only)

*When allowed by installation configuration.

Refer to the display's pilot guide for transponder control operation that is specific to each display.

3 DISPLAY FUNCTIONS AND SETTINGS

The GTX 3X5 is organized into four menu groups shown on the right-hand side of the display. Each menu group contains a set of functions and settings. Menu groups include:

- Transponder (XPDR) ◦ Timers (TMR) ◦ Altitude (ALT) ◦ System (SYS)

1. To navigate between the menu groups, press the **FUNC** key.
2. To navigate up or down and between the functions and settings within a current menu group, press the **8▲** or **9▼** keys.

When enabled by installation configuration, the menu group last selected and the functions last used within that menu group are saved and restored at system power on. Otherwise, function navigation resets to the default state at system power on.

3.1 Transponder (XPDR)

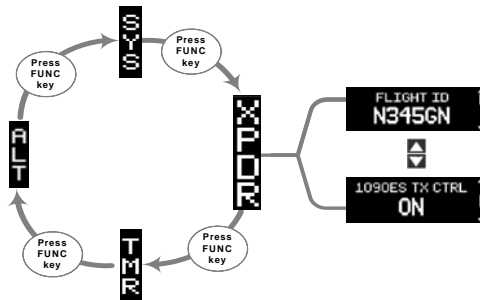

FLIGHT ID – This page displays the active Flight ID. Unless configured, the Flight ID is not editable. If configured, the Flight ID Edit prompt displays, as shown in figure 3-1. To edit the Flight ID use the **ENT** and **CLR** keys.

For an example of the editable Flight ID page refer to figure 3-2.



Figure 3-1 Flight ID Edit Display Page

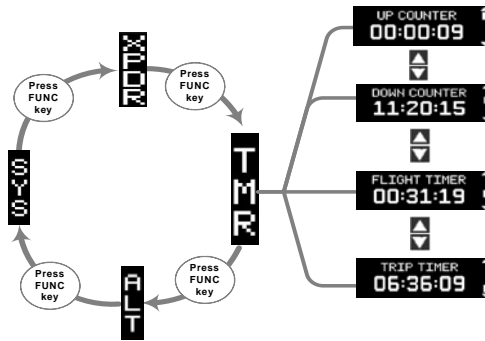

Figure 3-2 Flight ID Editable Display Page



1090ES TX CTRL – This page displays the current ON/OFF state of the 1090ES ADS-B Out function. Access to pilot control of the 1090ES ADS-B Out function is through this page when allowed by system configuration.

3.2 Timers (TMR)



UP COUNTER
00:00:09

UP COUNTER – This page provides a stopwatch style counter. Manual start/stop/reset controls are via the **ENT** and **CLR** keys.

DOWN COUNTER
11:20:15

DOWN COUNTER – This page provides notification in a count down style timer when the timer expires. Manual start/stop/set/reset controls are via the **ENT** and **CLR** keys.

FLIGHT TIMER
00:31:19

FLIGHT TIMER – This page provides an airborne flight timer that automatically starts and stops with the GTX automatic airborne determination. The timer measures the elapsed airborne time since the last on ground-to-airborne transition. Manual start/stop/reset controls are via the **ENT** and **CLR** keys.

TRIP TIMER
06:36:09

TRIP TIMER – This page provides an airborne flight timer that automatically starts and stops with the GTX automatic airborne determination. The timer measures the elapsed airborne time since the last manual reset of the timer. Manual start/stop/reset controls are via the **ENT** and **CLR** keys.

3.3 Altitude (ALT)

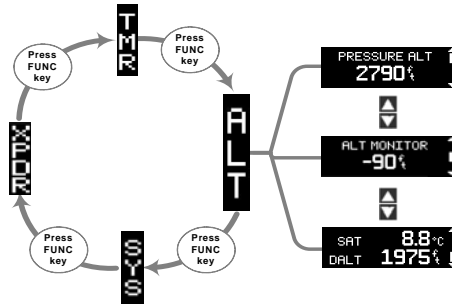

PRESSURE ALT
2790 ft

PRESSURE ALT – This page displays the current pressure altitude.

ALT MONITOR
-90 ft

ALT MONITOR – This page displays the current altitude deviation from the altitude chosen to maintain. When the altitude monitor is turned on it is automatically set to the current altitude.

Example: If the monitor is turned on at 9,500 ft, the monitor will trip when at 9,250 ft. or 9,750 ft., unless the installer configured the deviation limit to something other than the default value of 250 ft.

If deviation is greater than the deviation limit (default is 250 ft.), the GTX will display “LEAVING ALTITUDE” for two seconds. It will then switch to the altitude monitor page. If the altitude alert is configured to “Message” or “Message + Chime,” the GTX will aurally alert “leaving altitude.” The GTX will reset the monitor when the aircraft’s altitude returns within the deviation limit.

ON/OFF controls are via the **CRSR** and **ENT** keys.

SAT 8.8°C
DALT 1975 ft

SAT/DALT – This page displays the current static air temperature (SAT) and density altitude (DALT), when available.

3.4 System (SYS)

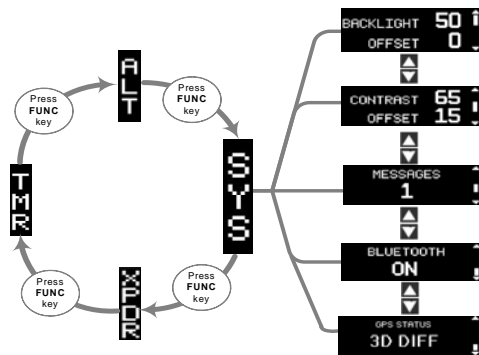

BACKLIGHT – This page displays the current backlight level and backlight level offset. The backlight level offset is via the **CRSR** and **8 ▲** and **9 ▼** keys.



CONTRAST – This page displays the current contrast level and contrast level offset. The contrast level offset is via the **CRSR** and **8 ▲** and **9 ▼** keys.



NOTE

Messages are not high priority. Their purpose is to provide additional information on abnormal system behavior. They do not require immediate pilot action. Any transponder failure will immediately display an alert with no pilot action necessary to view the alert. For troubleshooting failure messages, refer to section 7.



MESSAGES – This page displays the number of active system messages. Viewing active system messages is via the **CRSR** key selection.



BLUETOOTH (GTX 345) – This page displays the status of the GTX 345 Bluetooth function. This page will not display when the GTX 345 connects to a GX000 or GTN over HSDB. The Bluetooth function is automatically placed into pairing mode when this page is displayed. Pairing must be initiated by the PED and then confirmed on the GTX 345. The last 13 paired PEDs and 6 Bluetooth Low Energy (BLE) devices are saved. At system power on, the GTX 345 automatically connects to any available and previously saved paired PEDs. PEDs that are currently connected and paired are viewed/deleted via the **CRSR** and **8 ▲** and **9 ▼** keys. For instructions on Bluetooth pairing refer to section 3.4.1. For information on Connex Bluetooth features, refer to section 6.



GPS STATUS – This page displays the status of all configured GPS sources. The GPS position fix details are viewed via **CRSR** key selection.

3.4.1 Bluetooth Pairing Instructions

For first time activation of Bluetooth devices:

1. Go to the GTX 345 Bluetooth page to enable pairing mode. Refer to figure 3-3. If connected to a GTN or GX000 via HSDB, refer to the display's pilot's guide.
2. Enable Bluetooth on the PED.
3. Select "GTX 345" from the list of available devices on the PED. Refer to manufacturer's information for pairing instructions.
4. When a PED sends a pairing request the Bluetooth Pair Request page will display the device name and passkey. Refer to figure 3-4.
5. Press **ENT** on the GTX 345 and accept the pairing request on PED.



Figure 3-3 Bluetooth Page



Figure 3-4 Bluetooth Pair Request Page

3.4.2 Bluetooth Paired Device Information

To view the paired device list:

1. Press the **CRSR** key.

To view the menu and pairing status:

1. Press the **8▲** and **9▼** keys, respectively.
2. Then press the **ENT** key.

The Paired Devices list page will display. Refer to figure 3-5.

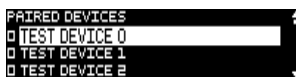

Figure 3-5 Paired Device List Page

More information about each paired device and applicable settings can be found by doing the following steps:

To set the auto-reconnect status:

1. Highlight the paired device.
2. Then press **ENT** key. Refer to figure 3-6.



Figure 3-6 Auto-reconnect Page

To unpair a device:

1. Highlight the device to be unpaired.
2. Then press the **ENT** key. Refer to figure 3-7.



```
TEST DEVICE 0
MAC ADDR: 00-04-03-02-01-00
UNPAIR DEVICE? YES
```

Figure 3-7 Unpair Device? Page

To view the device name on the Bluetooth page:

1. Press the **ENT** key.
2. Use the **8** ▲ and **9** ▼ keys, highlight the device's name to view.
3. Then press the **ENT** key. Refer to figure 3-8.



```
BLUETOOTH DEVICE NAME
GTX 3X5
```

Figure 3-8 (Selected) Bluetooth Device Name Page

4 ADS-B IN TRAFFIC (GTX 345 ONLY)



NOTE

Inherent inaccuracies exist in TIS-B and TAS/TCAS traffic position data. Because of this the GTX 345 may at times be unable to correlate targets from multiple sources for the same aircraft. When this occurs, a single aircraft is tracked and displayed as two co-located targets.



NOTE

The GTX 345 will continue to receive ADS-B In information when in standby mode.

The GTX has two modes:

1. Airborne Situational Awareness (AIRB). AIRB is in operation in the en route environment, outside of five NM from, and 1,500 feet above, the nearest airport.
2. Surface Situation Awareness (SURF). SURF is in operation within the terminal environment, within five NM and less than 1,500 feet above field elevation. When SURF is running airport map data and ground targets may be displayed as an aid to situational awareness.

ADS-B: Data transmitted directly from other aircraft.

ADS-R: Ground station rebroadcast of ADS-B data after data link translation (UAT to 1090 MHz or 1090 MHz to UAT). This function aids aircrafts only operating one frequency.
For more information about ADS-B refer to the FAA Aeronautical Information Manual (AIM), 4-5-7.

TIS-B: Ground station broadcast of secondary surveillance radar (SSR) derived traffic.

The GTX 345 receives ADS-B traffic data (ADS-B, ADS-R, TIS-B) through the UAT (978 MHz) and the 1090 MHz receivers. The GTX 345 may also receive traffic data from configured TAS/TCAS/TCAD. Traffic data is received, processed, and outputted to a connected display without pilot interaction. Traffic data may also be displayed on a PED (e.g., tablet) via the built-in Bluetooth interface or connected Flight Stream 110/210.

4.1 Traffic Alerting

To enhance situational awareness, the GTX 345 provides traffic alerting for ADS-B, ADS-R, and TIS-B targets. An aural message issues when an alert becomes active.

For example, "Traffic! Two O'clock, Low, Two Miles."

Alerting parameters provide enough time after an alert is generated to acquire the target and maneuver the aircraft away from the conflicting traffic. The alerting parameters consider:

1. Closure rate of each aircraft (ownship and target)
2. Altitude separation and trend
3. Speed
4. Angle

To minimize nuisance alerts, traffic alerting sensitivity is adaptive based on altitude above ground level. In fixed winged aircraft no aural alerts are given below 500 feet.

4.2 Helicopter Traffic Alerting

A helicopter with a GTX 345 connected to a Garmin navigator or radar altimeter offers additional traffic alerting for helicopter operations. Traffic alerting volumes are tailored to minimize nuisance alerts when operating in an airport environment at less than 200 feet AGL, and less than 60 knots groundspeed, while still providing alerts from airborne ADS-B equipped aircraft.

When in the airport environment alerting envelope, aural traffic alerts are shortened to "Traffic." Bearing, distance, and relative altitude information is omitted. There are no traffic alerts when groundspeed is less than 10 knots and within 50 feet of the ground.

4.2.1 On Scene Mode

On Scene Mode is pilot selectable. It changes traffic alerting volumes for other ADS-B equipped rotorcraft traffic. This allows helicopters to operate in closer proximity to each other without excessive nuisance alerts. The pilot must manually select the on and off mode for On Scene Mode. For information about controls and indications refer to the display's pilot guide.

4.2.2 No Source of Heading Data

Due to helicopter maneuverability, ground track may not correspond to heading at low speeds. Limitations apply to GTX 345 installations with no source of heading data provided.

ADS-B traffic will not display when operating at less than 15 knots groundspeed. Aural traffic alerts will issue, appropriately. If a TAS/TCAS is interfaced to the GTX 345 then:

- TAS/TCAS traffic targets will continuously display at all speeds.
- If in excess of 15 knots in backward or sideways flight, TAS/TCAS and ADS-B targets may not correlate. Two targets may appear on the display for each actual target being received over both ADS-B and TAS/TCAS.

4.3 TCAD/TAS/TCAS I GTX 345 Integration

To optimize situational awareness the GTX 345 correlates TCAD/TAS/TCAS with ADS-B In traffic, combining data from all sources. This creates the most accurate and comprehensive traffic picture. When a correlation is made the most relevant target is displayed. There are no duplicates. Any active traffic system, or ADS-B traffic that is not correlated, will also display.

When a GTX 3X5 and TAS/TCAS system integrate, the GTX 3X5 controls the operating mode of the TAS/TCAS system. It does this by using both its own air/ground logic and the available mode controls from the interfaced display. The GTX 345 provides all traffic aural alerts.

This page intentionally left blank.

5 FIS-B WEATHER AND FLIGHT INFORMATION

The GTX 345 Flight Information Services–Broadcast (FIS-B) function is capable of receiving weather and flight information. FIS-B is a subscription-free service that is broadcast over the UAT (978 MHz) data link. Reception of FIS-B data requires the aircraft to be within range and line-of-sight of a ground station. Because terrain may obstruct the signal, it may be necessary to gain altitude in order to receive the broadcast.

For information about FIS-B, and Aviation Weather Services and products, refer to the FAA Aeronautical Information Manual (AIM), 4-5-9 and AC 00-45, Aviation Weather Service. For information about weather data display and the associated symbology, refer to the display operator’s guide. Table 5-1 lists FIS-B weather products and the timing associated with each.

Transmission Interval is the time between the broadcast of a FIS-B product from a ground station. Update Interval is how often the FIS-B product updates with information from the data source provider.

Table 5-1 FIS-B Weather Products

Weather Product	Transmission Interval (Minutes)	Update Interval
CONUS NEXRAD	15	15 minutes
Regional NEXRAD	2.5	5 minutes
AIRMETs	5	6 hours or as needed
SIGMETs	5	As available. Every hour for convective SIGMETs.
METARS	5	15 minutes to 1 hour (METAR station dependent)
Winds and Temperatures Aloft	10	6 hours
Pilot Weather Report (PIREP)	10	As available.
TAFs	10	6 hours. As available for amended TAFs.
NOTAMs (includes TFRs)	10	As available.

**NOTE**

NOTAMs received via FIS-B may not be a complete listing. Active NOTAMs are removed from the FIS-B data stream 30 days after issuance. Before flight, review all necessary aeronautical and meteorological information from official sources. For more information, consult AC 00-63.

**NOTE**

Some Temporary Flight Restrictions (TFRs) may not appear, or the information may be incomplete. TFR Information shown is only advisory in nature. To determine accurate TFR information, verify with official sources, i.e., preflight planning or flight service center.

6 CONNEXT BLUETOOTH

The GTX 345 Connex interface allows communication with applications (i.e., Garmin Pilot and ForeFlight Mobile), while running on a PED. Connex works via the Bluetooth data link to provide up-to-date, wireless information throughout the cockpit. Refer to section 3.4 for Bluetooth pairing instructions. Up to two Bluetooth connections are supported by the GTX 345. Table 6-1 lists the GTX 345 Connex features.

Table 6-1 GTX 345 Connex Features

GTX 345 CONNEXT FEATURES
GPS Position and Velocity <ul style="list-style-type: none">• GPS position and velocity information used by the GTX 345's certified ADS-B functionality is made available to PEDs.
ADS-B In Traffic <ul style="list-style-type: none">• ADS-B In traffic data that is provided to certified traffic displays is made available to PEDs. This traffic is also combined with TCAD/TAS/TCAS traffic when the systems are integrated during installation.
FIS-B Weather and Flight Information <ul style="list-style-type: none">• FIS-B weather and flight information that is provided to certified displays is made available to PEDs.
Pressure Altitude <ul style="list-style-type: none">• Uncorrected barometric pressure altitude used by the GTX 345's certified transponder and ADS-B functionality is made available to PEDs.
Attitude and Heading Reference System (AHRS) <ul style="list-style-type: none">• When the GTX 345 is installed as part of an integrated flight deck (e.g., G500/G600, G1000), AHRS data from an AHRS source is made available to PEDs.• When the GTX 345 is installed as a stand-alone device, a built-in sensor provides AHRS data to PEDs via Connex. Attitude data is not output to other installed avionics.• The internal AHRS sensor is for use in fixed-wing aircraft only and is disabled in helicopter installations. All internal AHRS functions are automatic and no pilot action is required.

This page intentionally left blank.

7 TROUBLESHOOTING

The GTX 3X5 display system sends messages to the flight crew when trouble or otherwise abnormal conditions are detected. Table 7-1 outlines troubleshooting actions the flight crew may take to attempt to resolve each system message. If the actions taken do not resolve the message, or if there are any questions, the Garmin Product Support department is available Monday through Friday, 7:00 AM to 7:00 PM Central Time.

US: 913-397-8200

US Toll Free: 1-866-739-5687

Canada Toll Free: 1-866-429-9296

www.fly.garmin.com

To expedite your call, please have the following information ready.

1. System configuration (products, antennas, mounting location, etc.)
2. Model number, part number, and serial number
3. Software version(s)
4. Description of the problem
5. Efforts made to isolate/solve the problem

7.1 Transponder Failures

The screen in figure 7-1 shows when ADS-B is not transmitting and the aircraft may not be compliant with 14 CFR 91.225. However, the transponder is still operating. The screen in figure 7-2 shows if both the transponder and ADS-B are not transmitting and the aircraft may not be compliant with 14 CFR 91.215 and 14 CFR 91.225.



Figure 7-1 ADS-B 1090ES Failed Screen

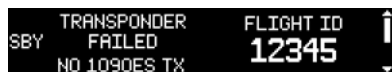

Figure 7-2 ADS-B 1090ES and Transponder Failed Screen

7.2 Transponder System Messages



NOTE

Messages are not high priority. Their purpose is to provide additional information on abnormal system behavior. They do not require immediate pilot action. Any transponder failure will immediately display an alert with no pilot action necessary to view the alert.

Depending on configuration, active messages display in the bottom left hand corner of the screen either as a flashing or solid MSG. If the MSG text is configured to flash, the text stops flashing when all active messages are read.

To view new messages:

1. Press **FUNC** key to SYS group.
2. Press **CRSR** then **ENT** key to view message.

Table 7-1 Troubleshooting

SYSTEM MESSAGE	EXPLANATION	FLIGHT CREW ACTION
1090 ADS-B In Failed	The GTX 3X5 has detected a 1090 receiver fault. Traffic picture may not be complete.	Contact dealer for service.
1090 ADS-B Out Failed	The unit cannot transmit ADS-B messages. Note: This message is present regardless of whether 1090 ES is on or off.	Contact dealer for service.
ADS-B In Failed	The GTX 3X5 has detected a fault in both 1090 and UAT receivers. ADS-B IN traffic and FIS-B will not be available.	Contact dealer for service.
ADS-B In Traffic Alerting Failed	The GTX 3X5 does not have enough information to provide traffic alerting on ADS-B targets.	<ol style="list-style-type: none"> 1. Check power and/or circuit breaker for the GPS position source (e.g., GTN or GNS). 2. Make sure the GPS antenna has a clear view of the sky and provide enough time for the GPS position source to obtain a position fix. Extended periods between use or GPS position source disconnection from the aircraft battery could cause a longer than normal GPS satellite acquisition time. If problem persists, contact dealer for service.

SYSTEM MESSAGE	EXPLANATION	FLIGHT CREW ACTION
ADS-B Position Input Failed	The unit is not receiving GPS.	<ol style="list-style-type: none"> 1. Check power and/or circuit breaker for the GPS position source (e.g., GTN or GNS). 2. Make sure the GPS antenna has a clear view of the sky and provide enough time for the GPS position source to obtain a position fix. Extended periods between use or GPS position source disconnection from the aircraft battery could cause a longer than normal GPS satellite acquisition time.
Demo Mode	The unit is operating in a mode intended for demonstration purposes.	<ol style="list-style-type: none"> 1. Restart the unit. 2. If problem persists, cycle avionics master power. 3. If problem persists, contact dealer for service.
FIS-B Weather Failed	The FIS-B receiver has failed. The display of FIS-B products may be unavailable.	Contact dealer for service.
Ground Test	The unit is operating in a mode intended for ground testing.	Restart the unit.
Maximum Temperature Exceeded	The unit is too hot. The transponder will not transmit until it has cooled.	Use alternate transponder as the active transponder, if available, to allow the GTX 3X5 to cool.
Minimum Temperature Exceeded	The unit is too cold. The transponder will not transmit until it has warmed up.	Allow time for the GTX 3X5 to warm up to ensure proper operation.
Pressure Altitude Failed	The GTX 3X5 has lost communication with the pressure altitude source.	Check power and/or circuit breaker for the pressure altitude source (e.g., altitude encoder, ADC, etc.).
Service Soon	GTX 3X5 has detected an internal fault but the unit will continue to function.	Contact dealer for service.
TAS/TCAS Failed	TAS/TCAS is reporting failed or the GTX 3X5 has lost communicating with the TAS/TCAS.	Check power and/or circuit breaker for the TCAD/TAS/TCAS I System.

SYSTEM MESSAGE	EXPLANATION	FLIGHT CREW ACTION
Traffic Processing Failed	The unit cannot process traffic because the unit isn't receiving enough information or the unit has an internal fault.	<ol style="list-style-type: none"> 1. Check power and/or circuit breaker for the GPS position source (e.g., GTN or GNS). 2. Make sure the GPS antenna has a clear view of the sky and provide enough time for the GPS position source to obtain a position fix. Extended periods between use or GPS position source disconnection from the aircraft battery could cause a longer than normal GPS satellite acquisition time. 3. Check Power and/or circuit breaker for the TCAD/TAS/TCAS I system.
UAT ADS-B In Failed	The GTX 3X5 has detected a UAT receiver fault. Traffic picture may not be complete.	Contact dealer for service.



© 2018 Garmin Ltd. or its subsidiaries

Part Number: 190-01499-00 Rev. F